

TOSHIBA CMOS Digital Integrated Circuit Silicon Monolithic

TC74ACT02P, TC74ACT02F, TC74ACT02FN, TC74ACT02FT

Quad 2-Input NOR Gate

The TC74ACT02 is an advanced high speed CMOS 2-INPUT NOR GATE fabricated with silicon gate and double-layer metal wiring C²MOS technology.

It achieves the high speed operation similar to equivalent Bipolar Schottky TTL while maintaining the CMOS low power dissipation.

This device may be used as a level converter for interfacing TTL or NMOS to High Speed CMOS. The inputs are compatible with TTL, NMOS and CMOS output voltage levels.

All inputs are equipped with protection circuits against static discharge or transient excess voltage.

Features

- High speed: $t_{pd} = 4.6 \text{ ns (typ.)}$ at $V_{CC} = 5 \text{ V}$
- Low power dissipation: $I_{CC} = 4 \mu\text{A (max)}$ at $T_a = 25^\circ\text{C}$
- Compatible with TTL outputs: $V_{IL} = 0.8 \text{ V (max)}$
 $V_{IH} = 2.0 \text{ V (min)}$
- Symmetrical output impedance: $|I_{OH}| = I_{OL} = 24 \text{ mA (min)}$
Capability of driving 50Ω transmission lines.
- Balanced propagation delays: $t_{pLH} \approx t_{pHL}$
- Pin and function compatible with 74F02

Note: xxxFN (JEDEC SOP) is not available in Japan.

TC74ACT02P

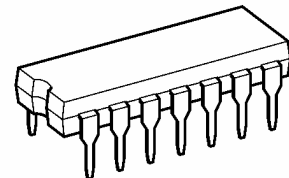

DIP14-P-300-2.54

TC74ACT02F

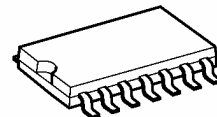

SOP14-P-300-1.27A

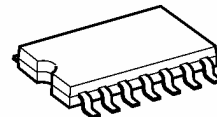

SOP14-P-300-1.27

TC74ACT02FN

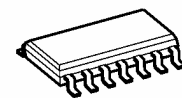

SOL14-P-150-1.27

TC74ACT02FT

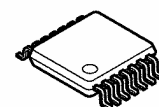

TSSOP14-P-0044-0.65A

Weight

DIP14-P-300-2.54	: 0.96 g (typ.)
SOP14-P-300-1.27A	: 0.18 g (typ.)
SOP14-P-300-1.27	: 0.18 g (typ.)
SOL14-P-150-1.27	: 0.12 g (typ.)
TSSOP14-P-0044-0.65A	: 0.06 g (typ.)

Pin Assignment

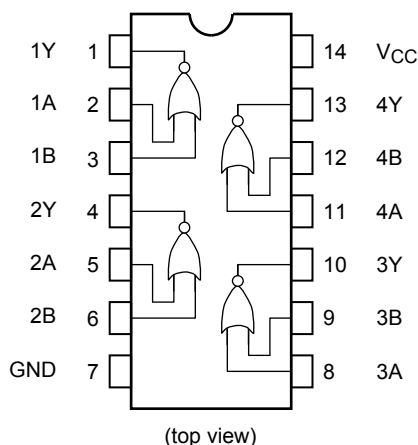

IEC Logic Symbol

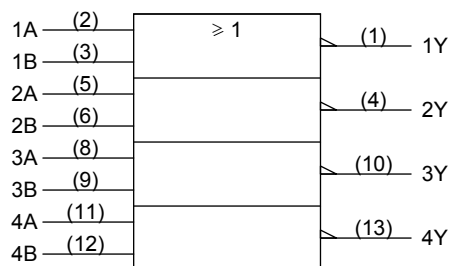

Truth Table

A	B	Y
L	L	H
L	H	L
H	L	L
H	H	L

Absolute Maximum Ratings (Note 1)

Characteristics	Symbol	Rating	Unit
Supply voltage range	V_{CC}	-0.5 to 7.0	V
DC input voltage	V_{IN}	-0.5 to $V_{CC} + 0.5$	V
DC output voltage	V_{OUT}	-0.5 to $V_{CC} + 0.5$	V
Input diode current	I_{IK}	± 20	mA
Output diode current	I_{OK}	± 50	mA
DC output current	I_{OUT}	± 50	mA
DC V_{CC} /ground current	I_{CC}	± 100	mA
Power dissipation	P_D	500 (DIP) (Note 2)/180 (SOP/TSSOP)	mW
Storage temperature	T_{stg}	-65 to 150	$^{\circ}C$

Note1: Exceeding any of the absolute maximum ratings, even briefly, lead to deterioration in IC performance or even destruction.

Note2: 500 mW in the range of $T_a = -40$ to $65^{\circ}C$. From $T_a = 65$ to $85^{\circ}C$ a derating factor of -10 mW/ $^{\circ}C$ should be applied up to 300 mW.

Recommended Operating Conditions (Note)

Characteristics	Symbol	Rating	Unit
Supply voltage	V_{CC}	4.5 to 5.5	V
Input voltage	V_{IN}	0 to V_{CC}	V
Output voltage	V_{OUT}	0 to V_{CC}	V
Operating temperature	T_{opr}	-40 to 85	°C
Input rise and fall time	dt/dV	0 to 10	ns/V

Note: The recommended operating conditions are required to ensure the normal operation of the device. Unused inputs must be tied to either V_{CC} or GND.

Electrical Characteristics

DC Characteristics

Characteristics	Symbol	Test Condition	$T_a = 25^\circ\text{C}$			$T_a = -40 \text{ to } 85^\circ\text{C}$		Unit	
			V_{CC} (V)	Min	Typ.	Max	Min		Max
High-level input voltage	V_{IH}	—	4.5 to 5.5	2.0	—	—	2.0	—	V
Low-level input voltage	V_{IL}	—	4.5 to 5.5	—	—	0.8	—	0.8	V
High-level output voltage	V_{OH}	$V_{IN} = V_{IL}$ $I_{OH} = -50 \mu\text{A}$ $I_{OH} = -24 \text{ mA}$ $I_{OH} = -75 \text{ mA}$ (Note)	4.5	4.4	4.5	—	4.4	—	V
			4.5	3.94	—	—	3.80	—	
			5.5	—	—	—	3.85	—	
Low-level output voltage	V_{OL}	$V_{IN} = V_{IH}$ or V_{IL} $I_{OL} = 50 \mu\text{A}$ $I_{OL} = 24 \text{ mA}$ $I_{OL} = 75 \text{ mA}$ (Note)	4.5	—	0.0	0.1	—	0.1	V
			4.5	—	—	0.36	—	0.44	
			5.5	—	—	—	—	1.65	
Input leakage current	I_{IN}	$V_{IN} = V_{CC}$ or GND	5.5	—	—	± 0.1	—	± 1.0	μA
Quiescent supply current	I_{CC}	$V_{IN} = V_{CC}$ or GND	5.5	—	—	4.0	—	40.0	μA
	I_C	Per input: $V_{IN} = 3.4 \text{ V}$ Other input: V_{CC} or GND	5.5	—	—	1.35	—	1.5	mA

Note: This spec indicates the capability of driving 50 Ω transmission lines.

One output should be tested at a time for a 10 ms maximum duration.

AC Characteristics ($C_L = 50 \text{ pF}$, $R_L = 500 \Omega$, input: $t_r = t_f = 3 \text{ ns}$)

Characteristics	Symbol	Test Condition	$T_a = 25^\circ\text{C}$			$T_a = -40 \text{ to } 85^\circ\text{C}$		Unit	
			V_{CC} (V)	Min	Typ.	Max	Min		Max
Propagation delay time	t_{pLH}	—	5.0 \pm 0.5	—	5.3	8.3	1.0	9.5	ns
	t_{pHL}								
Input capacitance	C_{IN}	—	—	5	10	—	10	pF	
Power dissipation capacitance	C_{PD}	(Note)	—	22	—	—	—	pF	

Note: C_{PD} is defined as the value of the internal equivalent capacitance which is calculated from the operating current consumption without load.

Average operating current can be obtained by the equation:

$$I_{CC (opr)} = C_{PD} \cdot V_{CC} \cdot f_{IN} + I_{CC}/4 \text{ (per gate)}$$

Package Dimensions

DIP14-P-300-2.54

Unit : mm

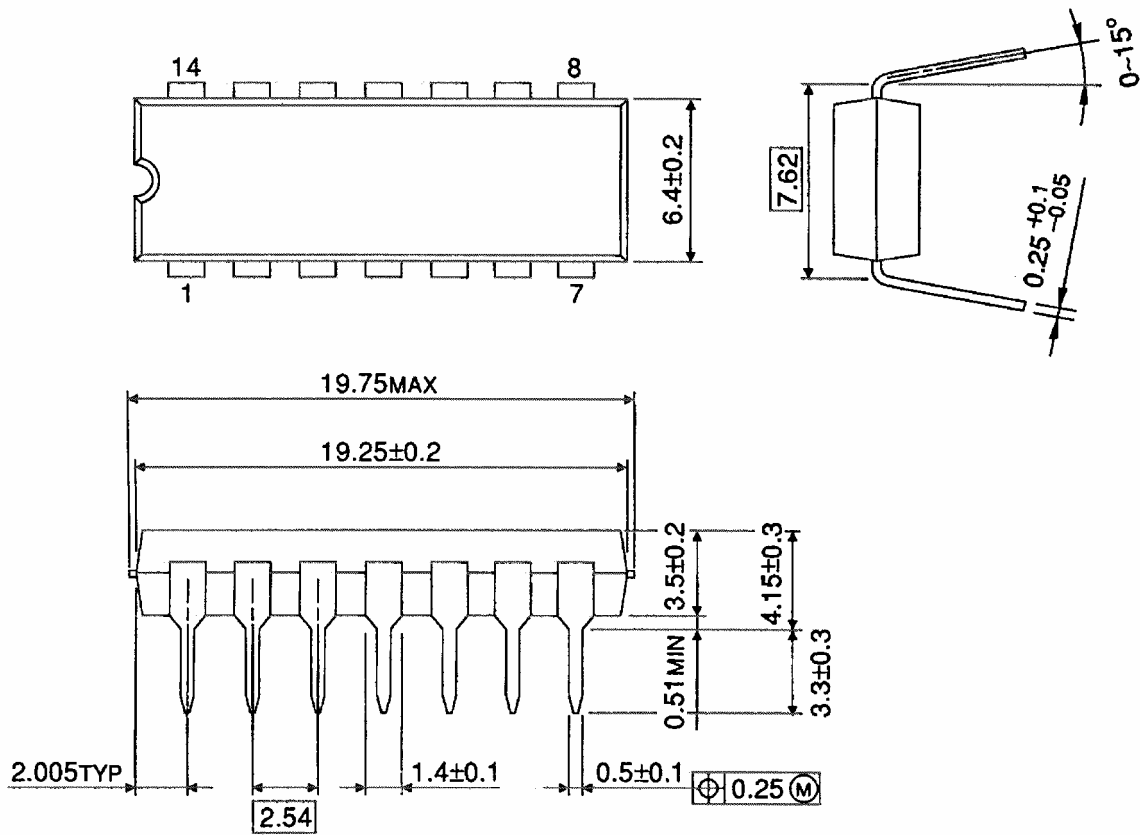

Weight: 0.96 g (typ.)

Package Dimensions

SOP14-P-300-1.27A

Unit: mm

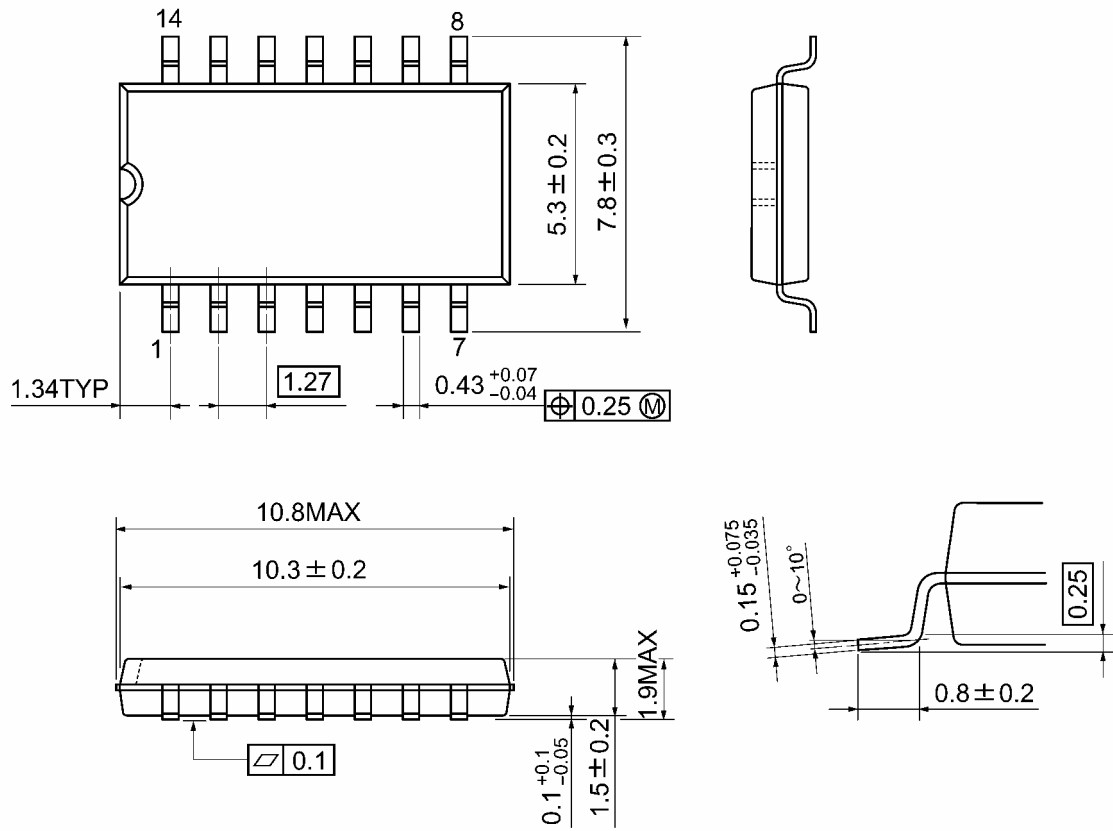

Weight: 0.18 g (typ.)

Package Dimensions

SOP14-P-300-1.27

Unit : mm

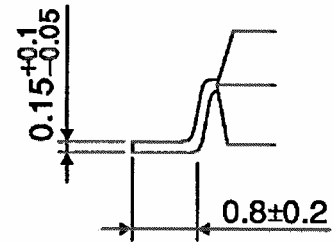
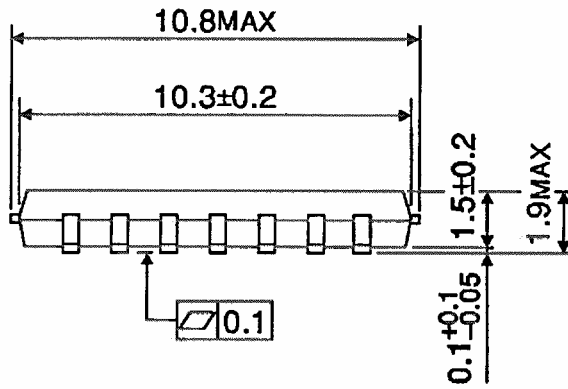
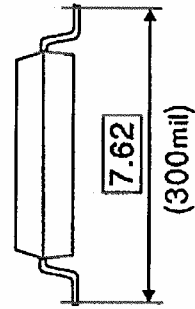
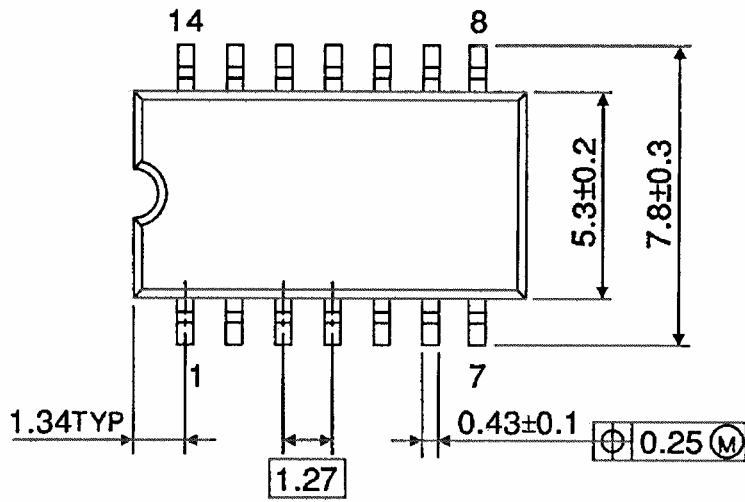

Weight: 0.18 g (typ.)

Package Dimensions (Note)

SOL14-P-150-1.27

Unit : mm



Note: This package is not available in Japan.

Weight: 0.12 g (typ.)

Package Dimensions

TSSOP14-P-0044-0.65A

Unit: mm

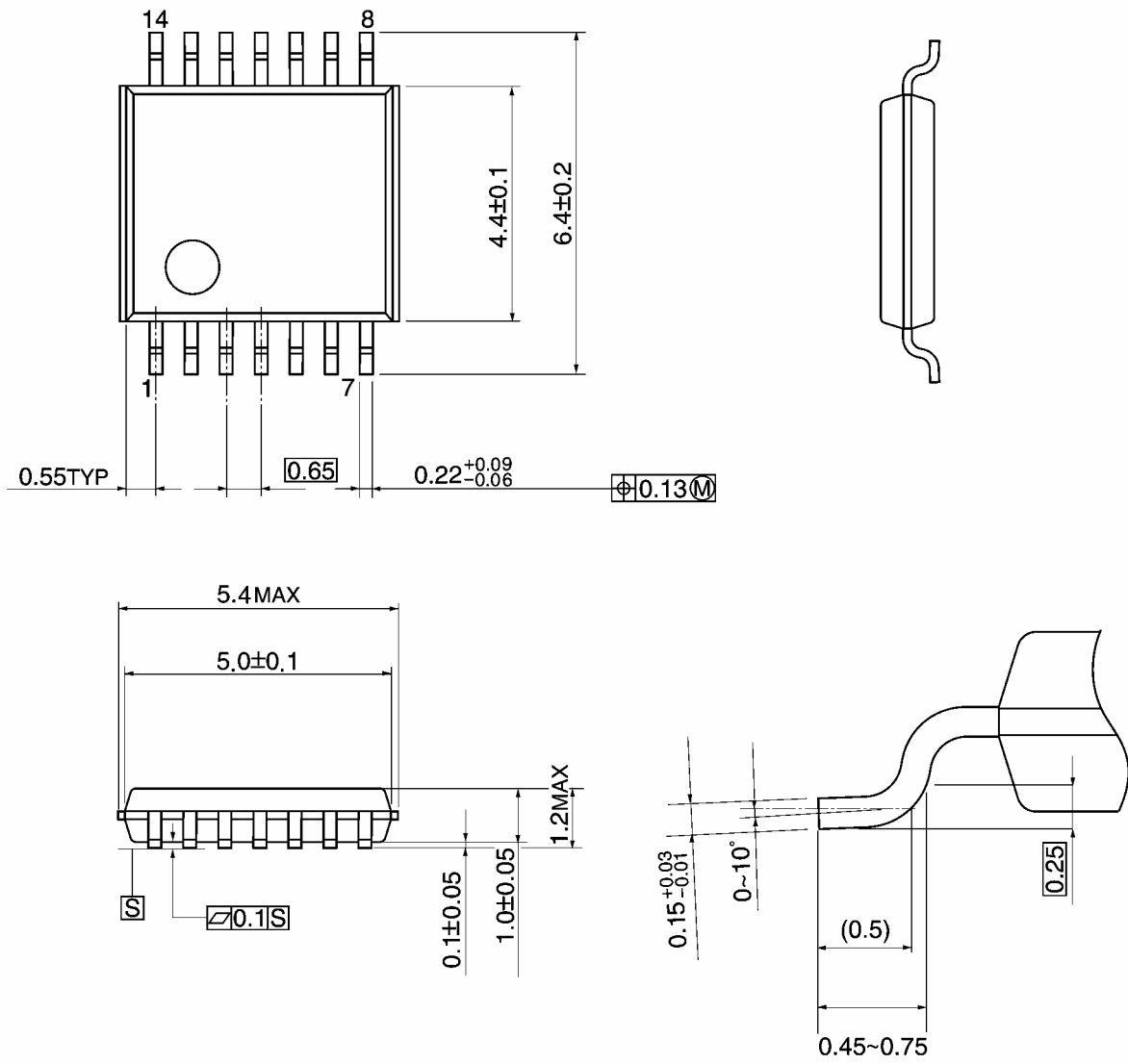

Weight: 0.06 g (typ.)

Note: Lead (Pb)-Free Packages**DIP14-P-300-2.54 SOP14-P-300-1.27A SOL14-P-150-1.27 TSSOP14-P-0044-0.65A****RESTRICTIONS ON PRODUCT USE**

20070701-EN

- The information contained herein is subject to change without notice.
- TOSHIBA is continually working to improve the quality and reliability of its products. Nevertheless, semiconductor devices in general can malfunction or fail due to their inherent electrical sensitivity and vulnerability to physical stress. It is the responsibility of the buyer, when utilizing TOSHIBA products, to comply with the standards of safety in making a safe design for the entire system, and to avoid situations in which a malfunction or failure of such TOSHIBA products could cause loss of human life, bodily injury or damage to property.
In developing your designs, please ensure that TOSHIBA products are used within specified operating ranges as set forth in the most recent TOSHIBA products specifications. Also, please keep in mind the precautions and conditions set forth in the "Handling Guide for Semiconductor Devices," or "TOSHIBA Semiconductor Reliability Handbook" etc.
- The TOSHIBA products listed in this document are intended for usage in general electronics applications (computer, personal equipment, office equipment, measuring equipment, industrial robotics, domestic appliances, etc.). These TOSHIBA products are neither intended nor warranted for usage in equipment that requires extraordinarily high quality and/or reliability or a malfunction or failure of which may cause loss of human life or bodily injury ("Unintended Usage"). Unintended Usage include atomic energy control instruments, airplane or spaceship instruments, transportation instruments, traffic signal instruments, combustion control instruments, medical instruments, all types of safety devices, etc.. Unintended Usage of TOSHIBA products listed in this document shall be made at the customer's own risk.
- The products described in this document shall not be used or embedded to any downstream products of which manufacture, use and/or sale are prohibited under any applicable laws and regulations.
- The information contained herein is presented only as a guide for the applications of our products. No responsibility is assumed by TOSHIBA for any infringements of patents or other rights of the third parties which may result from its use. No license is granted by implication or otherwise under any patents or other rights of TOSHIBA or the third parties.
- Please contact your sales representative for product-by-product details in this document regarding RoHS compatibility. Please use these products in this document in compliance with all applicable laws and regulations that regulate the inclusion or use of controlled substances. Toshiba assumes no liability for damage or losses occurring as a result of noncompliance with applicable laws and regulations.